

Product Catalogue

Glass Galore Tools and Solutions LLC

QUALITY FIRST, CUSTOMER FIRST, CREATE BRILLIANCE TOGETHER



Diamond wheel series



A001

Imported diamond wheels
Size:8x10 mm
D:150mm H:12,22mm
G:80, 140#



A002

Imported diamond wheels
Size: 6x10mm
D:150mm H:12,22mm
G:80, 140,180#



A003

Imported diamond wheels
Size:6x10 mm
D:150mm H:12,22mm
G:80, 140,180#



A004

Segmented diamond wheels
Size:10x10, 15x10mm
D:150,175mm H:12,22,50mm
G:80,100,120,140,180#



A005

Outer segmented diamond wheels
Size:8x10, 12x10mm
D:150,175mm H:12,22,50mm
G:80,100,120,140,180#



A006

Inner segmented diamond wheels
Size:8x10mm
D:150,175mm H:12,22,50mm
G:140,180,240#



A007

Diamond wheels
Size: 8x12, 10x12, 15x12mm
D:150mm H:12,22,50mm
G:100,140,180,240#



A008

Diamond wheels
Size: 5x10,6x10,5x12mm
D:150mm H:12,22mm
G:100,140,180,240#



A009

Inner segmented diamond wheels
Size: 8x8, 5x10, 10x10, 15x10mm
D:100,130,150,175mm H:12,22mm
G:140,180,240,320#



A010

Diamond wheels
Size:5x10mm
D:150mm H:120mm
G:80,120,140,180,240#



A011

Diamond wheels
D:150mm
H: Customized
G: Customized



A012

Diamond pencil wheels
D:60,80,100,150,175,200,220mm
H:22mm G.T:2-30mm
G:80,150,180,240#

Diamond wheel series



A013

Imported V-engraving wheels
D:140mm H:22mm
T:6, 8, 10mm
G: D54, D107#



A014

Diamond V-engraving wheels
D:100,150,200mm H:22mm
T:6,8,10mm
G: 80,120,150,180,240#



A015

Diamond wheels for CNC machine
D:100,150mm H:22mm
T:3,4,5,6,8,10,12,15,19mm
G:80,100,120,150,180,240#



A016

Diamond wheels for CNC machine
D:100,150mm
H:22,40,90mm T:15mm
G:100,150,180#



A017

Diamond wheels for CNC machine
D: 100,150mm
H:22,40,90mm T:15mm
G: 100,150,180#



A018

Diamond wheels for CNC machine
D:100,150mm
H:22mm T:6,8,10,12,15,19mm
G:100,150,180#



A019

Diamond wheels for CNC machine
D:100,150mm H:22,40,90mm
T:12,15,19mm
G:100,150,180#



A020

45 Degree electroplated wheels
D: 100,150mm H:22mm
T: 12,15,19mm
G:80,100,120,140,150,180,240#



A021

Electroplated pencil wheels
D:80,100mm H:22mm
T: 3,4,5,6,8,10,12,15,19mm
G:80,100,120,140,150,180,240#



A022

Electroplated 1/4 pencil wheels
D:100,150mm H:22mm
T:8,10,12,15,19mm
G:80,100,120,140,150,180,240#



A023

45 Degree electroplated wheels
D:100,150mm H:22mm
T: 8,10,12,15,19mm
G:80,100,120,140,150,180,240#



A024

Electroplated double groove wheels
D:150,200mm H:22mm
T:3,4,5,6mm
G:80,100,120,140,180,240#

Diamond wheel series



A025

1-OG Diamond wheels
D:100,150 mm H:22mm
T:8,10,12,15,19mm
G:80,100,120,180,240,270#



A026

2-OG Diamond wheels
D:100,150mm H:22mm
T:10,12,15,19mm
G:80,100,120,180,240,270#



A027

3-OG Diamond wheels
D:100,150mm H:22mm
H:22mm T:10,12,15,19mm
G:80,100,120,180,240,270#



A028

45° Slope diamond wheels
D:100,150 mm H:22mm
T:12,15,19mm
G:80,100,120,180,240,270#



A029

45° Slope diamond wheels
D:100,150mm H:22mm
T:12,15,19mm
G:80,100,120,180,240,270#



A030

45° Slope diamond wheels
D:100,150mm H:22mm
T: 10, 12, 15, 19
G:80,100,120,180,240,270#



A031

45° Slope diamond wheels
D:100,150 mm H:22mm
T:12,15,19mm
G:80,100,120,180,240,270#



A032

45° Slope diamond wheels
D:100,150mm H:22mm
T: 8, 10, 12, 15, 19mm
G:80,100,120,180,240,270#



A033

1/4 Diamond pencil wheels
D:100,150mm H:22mm
T: 8, 10, 12, 15, 19mm
G:80,100,120,180,240,270#



A034

Diamond flat with arising wheels
D:100,150,175,200mm H:22mm
T:4,5,6,8,10,12,15,19mm
G:180,140,180,240#



A035

Resin grinding plates
D:200,250,300mm H:22,32mm
T: 50,70,80,100mm
G:180,240,320#



A036

Diamond grinding plates
D:80,100mm H:22mm
T: 20x3mm
G: 80,120,240mm

Diamond wheel series

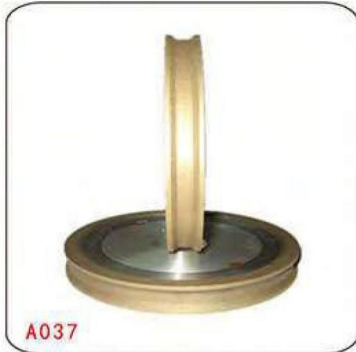

A037

Diamond flat with arising wheels
D:80,100,150,200mm H:22mm
T:3,4,5,6,8,10,12,15,19mm
G:80,100,150,180,240#



A038

Diamond pencil wheels
D:80,100mm H:22mm
T:3,4,5,6,8,10,12,15,19mm
G:80,100,150,180,240#



A039

Diamond flat edge wheels
D:100,150,200mm H:22mm
T:10,12,15,19mm
G:80,100,150,180,240#



A040

Diamond V-engraving wheels
D:150,160mm H:22mm
T:3,4,5,6,8,10,12,15mm
G:80,100,150,180,240,320#



A041

Diamond U-engraving wheels
D:80,100,150mm H:22mm
T:3,4,5,6,8,10,12,15mm
G:80,100,150,180,240,320#



A042

Diamond flat engraving wheels
D:80,100,150mm H:22mm
T:3,4,5,6,8,10,12,15mm
G:80,100,150,180,240,320#



A043

Diamond V-engraving wheels
D:100,150,160mm H:22mm
T:6,8,10,12,15,19mm
G:80,120,150,180,240#



A044

Diamond flat with arising wheels
D:100,150mm H:22mm
T:3,4,5,6,8,10,12,15,19mm
G:80,100,120,150,180,240#



A045

Diamond V-groove wheels
D:130,150mm H:12mm
T:Customized
G:80,120,150,180,240#

Resin wheel series



B001
Imported resin wheels
Size:20×12mm
D:150mm H:12,22mm



B002
Imported resin wheels
Size:20×12mm
D:150mm H:12,22mm

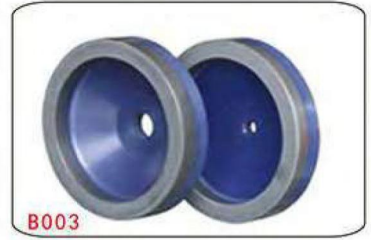

B003
Imported resin wheels
Size:15×10 mm
D:150mm H:12,22mm



B004
Imported resin wheels
Size:15×10mm
D:150mm H:12,22mm



B005
Imported resin wheels
Size:16×10mm
D:150mm H:12,22mm



B006
Imported resin wheels
Size:15×10 mm
D:150mm H:12,22mm



B007
Imported resin wheels
Size:15×10mm
D:150mm H:12,22mm



B008
Imported resin wheels
Size:20×12mm
D:150mm H:12,22mm



B009
Imported two grits resin wheels
Size:15×10 mm
D:150mm H:12,22mm



B010
Resin wheels
Size: 10×10,15×10,15×12mm
D: 100,130,150,175mm
H: 12,22,50mm



B011
Resin wheels
Size: 10×10,15×10,15×12mm
D: 100,130,150,175mm
H: 12,22,50mm



B012
Resin wheels
Size: 10×10,15×10,15×12mm
D: 100,130, 150,175mm
H: 12,22,50mm

Resin wheel series



B013

Resin wheels
Size:20×10mm
D:150mm H:12,22mm
G:3#,4#,5#,6#,7#



B014

Resin wheels
Size:16×10mm
D:150mm H:12,22mm
G:3#,4#,5#,6#,7#



B015

Resin wheels
Size:16×10mm
D:150mm H:12,22mm
G:3#,4#,5#,6#,7#



B016

Resin wheels
Size:15×12mm
D:150mm H:12,22mm
G:3#,4#,5#,6#,7#



B017

Resin wheels
Size:15×12mm
D:150mm H:12,22mm
G:3#,4#,5#,6#,7#



B018

Resin wheels
Size:15×12mm
D:150mm H:12,22mm
G:3#,4#,5#,6#,7#



B019

Resin wheel
Size:16×10mm
D:150mm H:12,22mm
G:3#,4#,5#,6#,7#



B020

Black resin wheels
Size:15×10mm
D:150mm H:12,22mm
G:3#,4#,5#,6#,7#



B021

Three-band resin wheels
Size:16×10mm
D:150mm H:12,22mm
G:3#,4#,5#,6#,7#



B022

Three-band resin wheels
Size:16×10mm
D:150mm H:12,22mm
G:3#,4#,5#,6#,7#



B023

Resin wheels
Size:Customized
D:150mm H:Customized
G:Customized



B024

Engraving resin wheels
G.T: 3,4,5,6,8,10,12,15,19mm
D:150mm H:22mm
G:3#,4#,5#,6#,7#

Four sides wheel series



C001

Diamond wheels for four sides edger
D:150mm H:10,22mm
T:15,20,25,30,35,40mm G:150,240,320mm



C002

Diamond wheels for four sides edger
D:150mm H:10,22mm
T:15,20,25,30,35,40mm G:150,240,320mm



C003

Resin wheels for four sides edger
D:150mm H:10,22mm
T:15,20,25,30,35,40mm G:200mm



C004

Resin wheels for four sides edger
D:150mm H:10,22mm
T:40mm G:200mm



C005

Diamond wheels for four sides edger
D:160mm H:68mm
T:40mm G:200mm



C006

Diamond wheels for four sides edger
D:160mm H:68mm
T:40mm G:200mm

Polishing wheel series



D001

Imported AO polishing wheels
D: 150mm H: 50,70mm T: 40mm



D002

Germany AO polishing wheels
D: 150mm H: 100mm T: 25mm



D003

Imported CE3 polishing wheels
D: 150mm H: 70mm T: 40mm



D004

Imported X5000 polishing wheels
D: 150mm H: 50,70mm
T: 30,40mm



D005

Imported 10S40 polishing wheels
D: 130,150mm H: 22,60,70mm
T: 30,35,40mm G: 40,60,80,120#



D006

Imported 10S60 Polishing wheels
D: 130,150mm H: 22,60,70mm
T: 30,35,40mm G: 40,60,80,120#



D007

Imported 10S Polishing wheels
D: 130,150mm H: 22,60,70mm
T: 35,40mm G: 46,60,80,120#



D008

England BK polishing wheels
D: 150mm H: 100mm
T: 25mm G: 46,60#



D009

England BK polishing wheels
D: 130,150mm H: 50,70mm
T: 35,40mm G: 46,60,80,120#



D010

X081 Polishing wheels
D: 150mm H: 50,70mm
T: 30,40mm



D011

CE3 Polishing wheels
D: 150mm H: 50,70mm
T: 40mm



D012

CE3 Polishing wheels
D: 150mm H: 50,70mm
T: 40mm



D013

SD001 Polishing wheels
D: 150mm H: 70mm T: 30,40mm



D014

SD001 Polishing wheels
D: 150mm H: 70mm T: 30,40mm



D015

X5000 Polishing wheels
D: 150mm H: 50,70mm T: 30,40mm

Polishing wheel series



D016

X3000 Polishing wheels
D:100,130,150mm
H:50,60,70mm
T:30,35,40mm



D017

X5000 Polishing wheels
D:100,130,150mm
H:50,60,70mm
T:30,35,40mm



D018

X5000 Polishing wheels
D:100,130,150mm
H:50,60,70mm
T:30,35,40mm



D019

10S80 Polishing wheels
D:130,150mm H:22,60,70mm
T:30,35,40mm G:40,60,80,120#



D020

10S120 Polishing wheels
D:130,150mm H:22,60,70mm
T:30,35,40mm G:40,60,80,120#



D021

10S40 Polishing wheels
D:130,150mm H:22,60,70mm
T:40mm G:40,60,80,120#



D022

9RS40 Polishing wheels
D:130,150mm H:22,50,70mm
T:30,35,40mm G:40,60,80,120#



D023

9RS80 Polishing wheels
D:130,150mm H:22,50,70mm
T:30,35,40mm G:40,60,80,120#



D024

9RS60 Polishing wheels
D:130,150mm H:22,50,70mm
T:30,35,40mm G:40,60,80,120#



D025

9RS80 Polishing wheels
D:130,150mm H:22,50,70mm
T:30,35,40mm
G:40,60,80,120#



D026

Polyurethane wheels
D:130,150mm H:22,60,70mm
T:30,35,40mm
G:40,60,80,120#



D027

Polyurethane wheels
D:150mm H:50,70mm
T:35,40mm

Polishing wheel series



D028

BK Polishing wheels
D: 150,200mm H: 22,90mm
T: 15,20,25,30mm
G: 46,60,80,120#



D029

BK Polishing wheels
D: 150mm H: 100mm
T: 25mm
G: 46,60,80,120#



D030

BK Polishing wheels
D: 130,150mm H: 60,70mm
T: 35,40mm
G: 46,60,80,120#



D031

BD Polishing wheels
D: 100,130,150mm
H: 12, 22,50mm
T: 30, 35,40mm



D032

BD Polishing wheels
D: 100,130,150mm
H: 12,22,50mm
T: 30,35,40mm



D033

BD Polishing wheels
D: 100,130,150mm
H: 12, 22,50mm
T: 30, 35,40mm



D034

CNC BD Polishing wheels
D: 100,150,200mm
H: 22,50,90mm
T: 15,20,25,30mm



D035

BD Polishing wheels
D: 100,150mm
H: 22,50,90mm
T: 15,20,25,30mm



D036

BD Polishing wheels
D: 25,30,50mm
H: 12,22mm
T: 12,20,25,30,35mm



D037

BD Engraving wheels
D: 150,200mm H: 22,90mm
T: 30mm



D038

BD Engraving wheels
D: 150,200mm H: 22,90mm
T: 30mm



D039

45°BD Engraving wheels
D: 100mm H: 22mm
T: 30mm

Polishing wheel series



D040

U-shape BD Engraving wheels
D: 150,165,175,200mm
H: 22,40,50,90mm
T: 5,6,8,10,12,15,20mm



D041

V-shape BD Engraving wheels
D: 150,165,175,200mm
H: 22,40,50,90mm
T: 5,6,8,10,12,15,20mm



D042

Stone polishing wheel s
D: 100,130,150mm
H: 12,22,50,70mm
T: 30,35,40mm



D043

Stone polishing wheels
D: 100,130,150mm
H: 12,22,50,70mm
T: 30,35,40mm



D044

Stone polishing wheel
D: 100,130,150mm
H: 12,22,50,70mm
T: 30,35,40mm



D045

Stone polishing wheel s
D: 100,130,150mm
H: 12,22,50,70mm
T: 30,35,40mm



D046

Stone polishing wheels
D: 100,130,150mm
H: 12,22,50,70mm
T: 30,35,40mm



D047

Stone polishing wheels
D: 100,130,150mm
H: 12,22,50,70mm
T: 30,35,40mm



D048

Stone polishing wheel s
D: 100,130,150mm
H: 12,22,50,70mm
T: 30,35,40mm



D049

Spongy wheels
D: 150,200,250,300mm
H: 16,25mm T: 20,25mm
G: 180,240,320#



D050

Coating deletion wheels(dry use)
D: 100, 150,200mm
H: 22,50,76.2mm
T: 8,10,12,15,20,25mm



D051

Coating deletion wheels(dry use)
D: 50,60,65mm
H: 6mm
T: 6,8,10,15,20,25,30mm

Felt wheel series



E001

Felt wheels with polishing powder
D: 130, 150mm
H: 60, 70, 105, 115mm
T: 25, 30, 35, 40mm



E002

Felt wheels with polishing powder
D: 130, 150mm
H: 60, 70, 105, 115mm
T: 25, 30, 35, 40mm



E003

Felt wheels with polishing powder
D: 130, 150mm
H: 60, 70, 105, 115mm
T: 25, 30, 35, 40mm



E004

Free polishing powder felt wheel
D: 100, 130, 150mm
H: 25, 60, 70, 105mm
T: 25, 30, 35, 40mm



E005

Free polishing powder felt wheel
D: 100, 130, 150mm
H: 25, 60, 70, 105mm
T: 25, 30, 35, 40mm



E006

Free polishing powder felt wheel
D: 150mm
H: 22, 70mm
T: 35, 40mm



E007

Felt wheels
D: 100, 130, 150, 185, 200mm
H: 60, 70, 105, 115mm
T: 25, 30, 35, 40mm



E008

Felt wheels
D: 100, 130, 150, 185, 200mm
H: 60, 70, 105, 115mm
T: 25, 30, 35, 40mm



E009

Pure felt wheels
D: 70, 150, 200, 250, 300mm
H: 12, 22, 70mm
T: 25, 30, 35, 40mm



E010

Felt wheels
D: 100, 130, 150, 185, 200mm
H: 60, 70, 105, 115mm
T: 25, 30, 35, 40mm



E011

Felt wheels
D: 100, 130, 150, 185, 200mm
H: 60, 70, 105mm
T: 30, 35, 40mm



E012

Felt wheels
D: 100, 130, 150, 185, 200mm
H: 60, 70, 105, 115mm
T: 25, 30, 35, 40mm

Ruler series

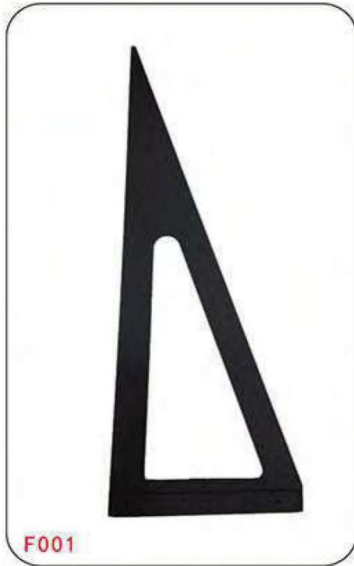

F001

Triangle ruler

Thickness:4,5, 6,8mm

Size:600, 800, 900,1000,
1200,1500,1800mm

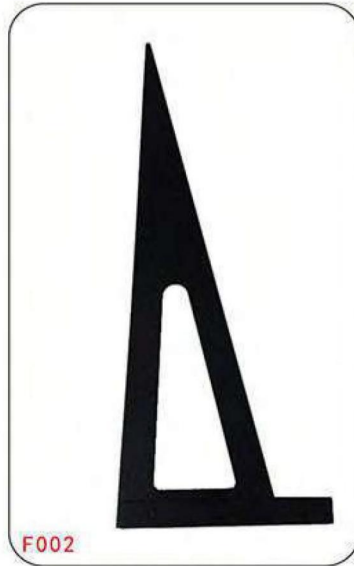

F002

Triangle ruler

Thickness:4,5,6,8mm

Size:600,800,900,1000,
1200, 1500,1800mm

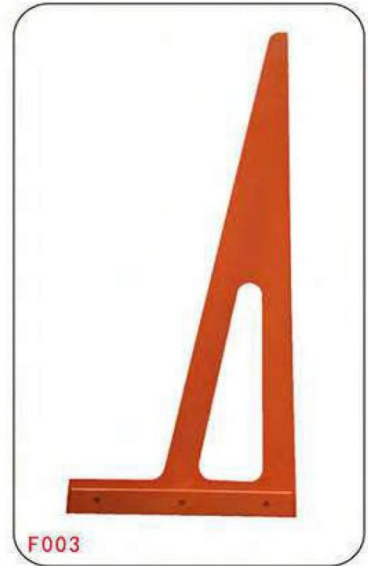

F003

Triangle ruler

Thickness:4,5,6,8mm

Size:600,800,900,1000,
1200,1500,1800mm

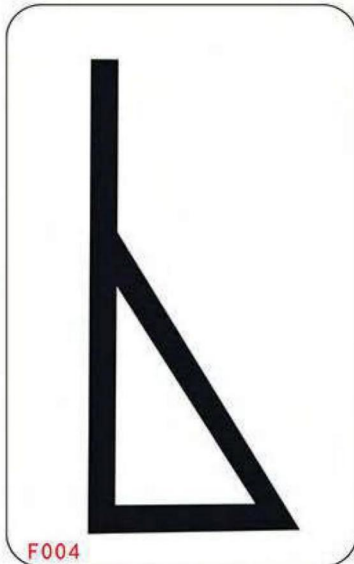

F004

R triangle ruler

Thickness:4,5, 6,8mm

Size:600, 800, 900,1000,
1200,1500,1800mm

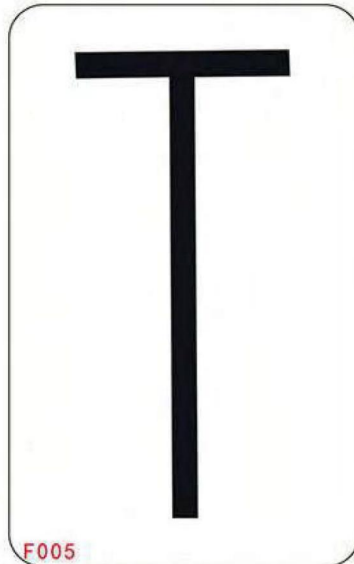

F005

T shape ruler

Thickness:4,5,6,8mm

Size:600,800,900,1000,
1200, 1500,1800mm

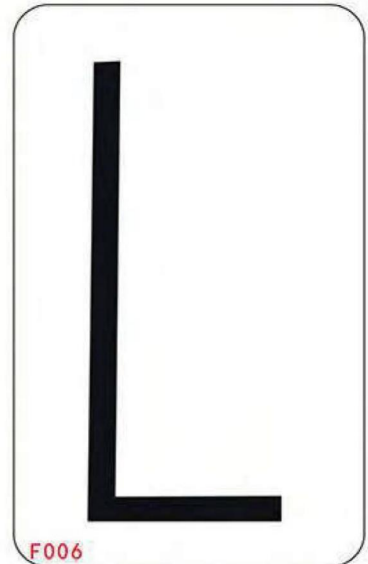

F006

L-square

Thickness:4,5,6,8mm

Size:600,800,900,1000,
1200,1500,1800mm

Ruler series



F007

Parallel ruler

Size:200×200,300×300,400×400mm

This product is made of high quality materials, cutting the parallel glass of different size.

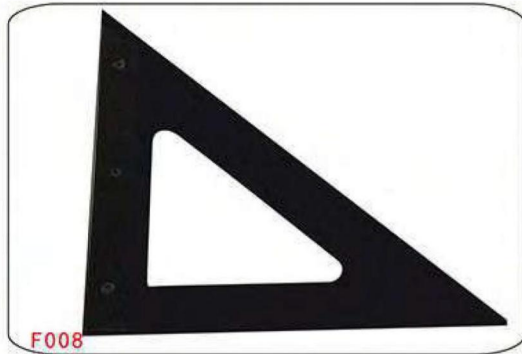

F008

45degree triangle ruler



F009

Corner radius cutter

High quality materials, with 2 fixed suction cup, can adjust the range of 45mm-250mm, can also be customized according to customer requirements.

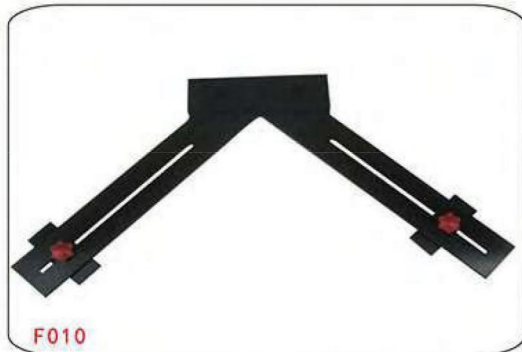

F010

Template for corner cut outs

High quality materials, with 2 fixed suction cup, can adjust the range of 45mm-250mm, can also be customized according to customer requirements.



F011

Adjustable triangle ruler



F012

Angle measuring template

Ruler series



Template for lateral cut outs (with scale)



Template for lateral cut outs



F015

New pattern angle measuring template
Size:600,800,1000,1200mm



F016

Angle measuring template
Size:600,800,1000,1200mm

This product is made of high-quality materials manufacturing, efficient cutting of glass is in the shape of bar, parallelogram, inclined junction, a diamond, a trapezoid, hexagon, eight angular shaped for decorative wall lamp, starts, the pattern of small greenhouse.

Ruler series



F017

T shape ruler (with scale)
Thickness: 4, 5, 6, 8mm
Size: 600, 800, 900, 1000,
1200, 1500, 1800mm



F018

1/4 Cutting ruler fan form
This product is used for cutting
the different size of glass sector.



F019

Round cutting ruler
This product is used for precision
cutting of different size of glass.

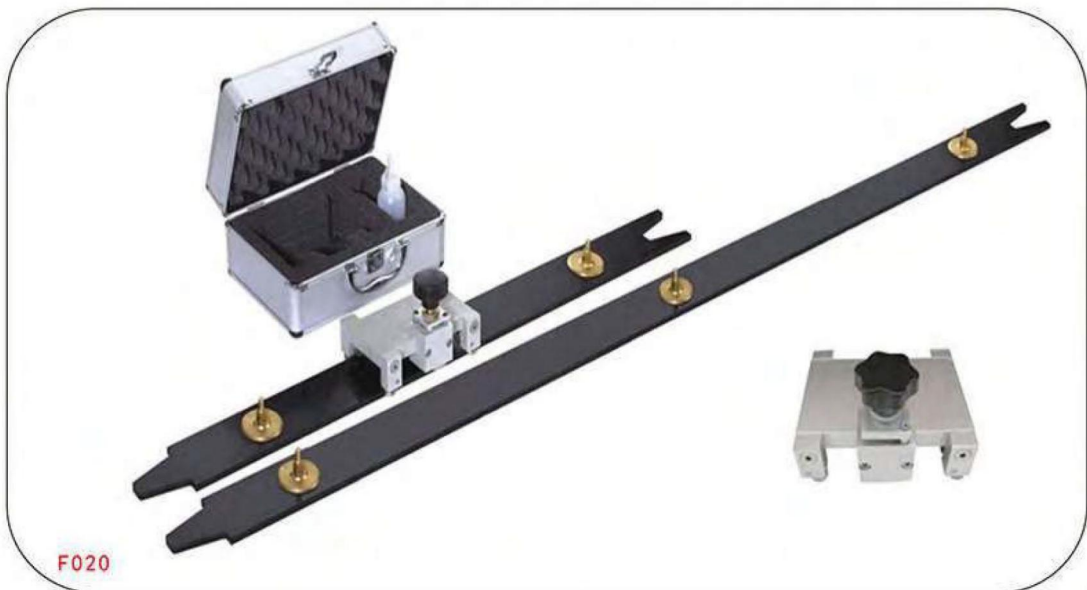

F020

Suction lath
Size: 500, 700, 1000, 1500, 2000, 2500, 3000, 3500mm

This product is made of high quality materials (electric board), material thickness has 8mm, 10mm, length 500mm-4500mm.

Ruler series



Triangle ruler (with scale)
Thickness:4,5 , 6,8mm
Size:600, 800, 900,1000,
1200,1500,1800mm



R shape ruler (with scale)
Thickness:4,5,6,8mm
Size:600,800,900,1000,
1200, 1500,1800mm



Parallel Ruler (New Model)
Thickness 4,5,6,8mm
Size :600,800,900,1000,
1200,1500,1800mm



T shape ruler

Glass carrying series



G001

1000kg Sheet lifting clamp
Glass thickness: 3-30mm
Weight: 29kg
Volumn: 730×210×680mm

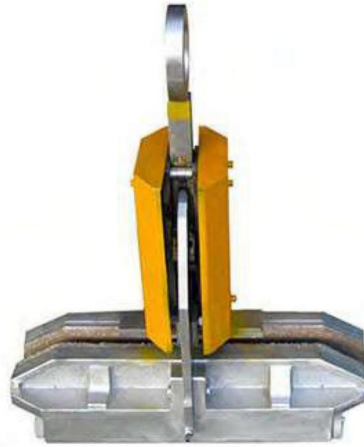

G002

500kg Sheet lifting clamp
Glass thickness: 3-30mm
Weight: 19 kg
Volumn: 580×210×650mm



G003

800kg Sheet lifting clamp
Glass thickness: 3-25mm
Weight: 15kg
Volumn: 550×260×260mm



G004

800kg Sheet lifting clamp
Glass thickness: 3-25mm
Weight: 15 kg
Volumn: 550×260×260mm

Glass carrying series



G005

Forklift hanger



G006

Glass carrying device

Glass thickness: 3-30mm

Max: 150kg



G007



G008

Glass lifting belt

Length: 3000mm

Max: 3000kg



G009

1000kg sheet lifting clamp

Glass thickness: 3-60mm

Weight: 30kg

Volum: 480x200x210

Glass carrying series



G010

Glass lifting belt

Length: 2.8, 3, 3.3, 3.8m

Max: 3T, 5T, 8T



G011

Glass lifting belt

Length: 2.8, 3, 3.3, 3.8m

Max: 3T, 5T, 8T



G012

Glass lifting belt

Length: 2.8, 3, 3.3, 3.8m

Max: 3T, 5T, 8T



G013

Parallel suspension beam

Glass machine series



H001
Imported drilling machine



H002
Drilling machine
Double rod drilling machine



H003
Drilling machine
Single rod drilling machine



H004
Drilling machine



H005
New small drilling machine



H006
Small drilling machine

Glass machine series



H007

Drilling machine



H008

Drilling machine



H009

Drilling machine



H010

Cutting machine



H011

New imported cutting machine



H012

Pneumatic glass chamfering machine



H013

Pneumatic glass chamfering machine



H014

Cutting machine

Glass machine series



H015

Pneumatic polishing machine



H016

Pneumatic polishing machine



H017

Electric polishing machine



H018

Coating deletion machine



H019

Coating deletion machine



H020

Belt sander



H021

Glass chamfering machine



H022

Pneumatic coating deletion machine



H023

Aluminum bar bending machine



H024

Air belt sander



H025

Glass scratch removal tool



H026

Grinding machine

Glass machine series



H031

Imported polishing machine



H032

Polishing machine



H033

Polishing machine



H034

Polishing machine



H035

Polishing machine



H036

110V Polishing machine



H037

Polishing machine



H038

Polishing machine



H039

Polishing machine

Glass machine series



H027

Polishing table machine



H028

Shape glass cutting machine (three arms)



H029

Round glass cutting table

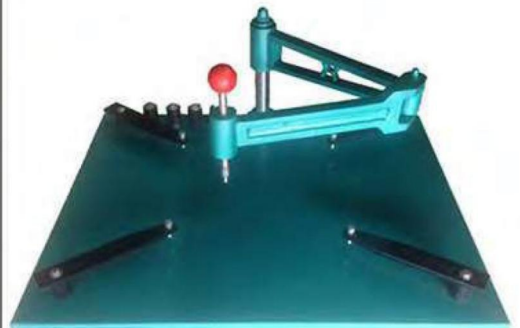

H030

Shape glass cutting table (two arms)

Glass protective tool series



I001

Protective wrist



I002

Protective wrist



I003

Protective wrist



I004

Protective wrist



I005

Protective wrist



I006

Protective wrist



I007

Protective wrist



I008

Protective wrist



I009

Protective wrist



I010

Protective gloves



I011

Protective gloves



I012

Protective gloves



I013

Protective gloves



I014

Protective gloves



I015

Protective gloves



I016

Protective gloves



I017

Protective gloves



I018

Protective gloves

Glass protective tool series



I019

Protective gloves



I020

Protective gloves



I021

Protective gloves



I022

Protective gloves



I023

Protective gloves



I024

Protective gloves



I025

Protective gloves



I026

Protective gloves



I027

Protective gloves



I028

Protective glasses



I029

Protective glasses



I030

Protective glasses



I031

Protective glasses



I032

Protective glasses



I033

Protective glasses



I034

Protective suit



I035

Protective hat
Protective sleeve

UV series



J001

Tin side detector



J002

Tin side detector



J003

Tin side detector



J004

Imported tin side detector



J005

Tempered glass testing light



J006

LED UV Torch



J007

Tempered glass testing light



J008

V:220V 50HZ 250W



J009

V:220V 50HZ 125W



J010

UV lamp
V:220V 50HZ 40, 80W



J011

UV lamp
V:220V 50HZ 40W



J012

UV lamp
V:220V 50H 12,16,48W

UV series



J013

Loxeal UV glue



J014

DDC UV glue



J015

Bohle UV glue



J016

6110 UV glue



J017

UV glue



J018

BBC UV glue

Circle cutter、T-cutter series

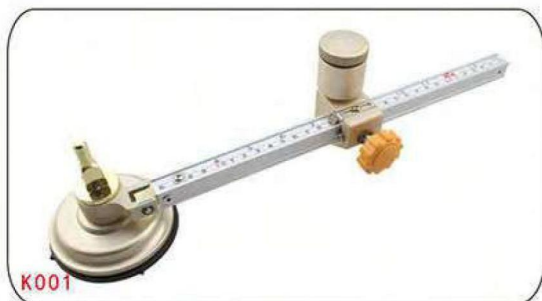

K001

Circle cutter
Length: 600,900,1200,1500,1800mm



K002

Circle cutter
Length: 600,900,1200,1500,1800mm



K003

Oval cutter
Length:600,1200,2200mm



K004

Circle cutter
Length: 600,900,1200,1500,1800mm



K005

Circle cutter
Length:400,600,800,1200,1500mm



K006

Circle cutter
Length:400,600,800,1200,1500mm



K007

Circle cutter
Length:400, 600,800,1200, 1500mm



K008

Circle cutter
Length:400,600,800,1200,1500mm

Circle cutter、T-cutter series



K009

T-cutter
Length:600,900,1200,1500,1800,2100mm

3-19mm



K010

T-cutter
Length:600,900,1200,1500,1800,2100mm

3-19mm

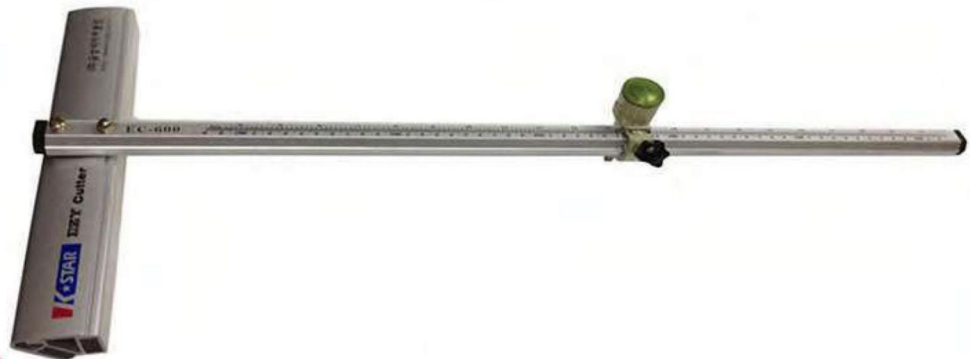

K011

T-cutter
Length:600,900,1200,1500,1800,2100mm

3-19mm

Circle cutter、T-cutter series



K012

T-cutter

Length:600,900,1200,1500,1800,2100mm

3-19mm



K013

T-cutter

Length:600,900,1200,1500,1800,2100mm

3-19mm



K014

T-cutter

Length:600,900,1200,1500,1800,2100mm

3-19mm

Circle cutter、T-cutter series



K015

T-cutter

Length:600,900,1200,1500,1800,2100mm

3-19mm



K016

T-cutter

Length:600,900,1200,1500,1800,2100mm

3-19mm



K017

Cutter head

Glass drilling series



L001

CNC Milling cutter
L: 75, 95, 105mm
D: 14×4, 16×4mm
T: 5, 6, 8, 10, 12, 15mm



L002

Milling cutter
L: 108mm
D: 10×3, 16×3, 20×(4,5)mm
T: 20mm



L003

Milling cutter
L: 80mm
D: (10, 12)×3, (14, 16, 18)×4,
(20, 22)×(4, 5), (24, 25, 26)×(5, 6)



L004

Drill bit
L: 75mm, 95mm
D: 3-100mm



L005

Drill bit
L: 75, 95mm
D: 3-100mm



L006

Drill bit
L: 75, 95mm
D: 4-150mm



L007

Drill bit
L: 75mm, 95mm
D: 3-100mm



L008

CNC Milling cutter
L: 75, 95mm
D: Customized



L009

Drill bit
L: 75, 95mm
D: 3-100mm

Glass drilling series



L010

Electroplated drill bit
D: 3-150mm



L011

Diamond drill bit
D: 3-150mm



L012

Drill bit
L: 75, 95mm D: 3-100mm



L013

Drill bit
L: 75, 95mm D: 3-100mm



L014

Drill bit
L: 75, 95mm D: 3-150mm



L015

Drill bit
L: 75, 95mm D: 3-150mm



L016

D: Customized



L017

L: 75, 95mm D: 3-100mm

Glass drilling series



L018

Countersink with slots
L:75,95mm D:0-16,0-80mm



L019

Countersink with slots
L:75,95mm D:0-16,0-80mm



L020

Electroplated countersink
D:0-15,0-60mm



L021

Countersink
D:5-130mm



L022

Special diamond grinding bit
D:Customized



L023

Special diamond grinding bit
D:Customized



L024

Special grinding head
D:Customized



L025

Screw

Glass cutter&plier series



M001

Glass scalloping plier



M002

Glass scalloping plier



M003

Garving plier



M004

Glass power plier

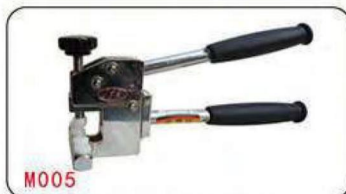

M005

Glass power plier



M006

Glass breaking plier



M007

Bend-nose plier



M008

Double-wheel glass plier



M009

Flat-nose plier



M010

Flat-nozzle plier



M011

Full round edge plier



M012

Glass clip



M013

Three boundaries plier



M014

Bend-nozzle plier



M015

Glass scalloping plier



M016

Glass plier



M017

Glass plier

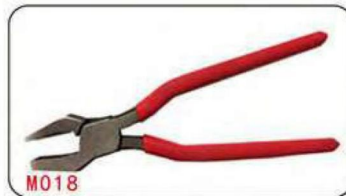

M018

Flat-nose plier

Glass cutter&plier series



Glass cutter
Size:2-6, 6-12, 15-19mm



Glass cutter
Size:2-6, 6-12, 15-19mm



Glass cutter
Size:2-6, 6-12, 15-19mm



Glass cutter
Size:2-6, 6-12, 15-19mm



Glass cutter
Size:2-6, 6-12, 15-19mm



Glass cutter
Size:2-6, 6-12, 15-19mm



Glass cutter
Size:2-6, 6-12, 15-19mm



Glass cutter
Size:2-6, 6-12, 15-19mm



Glass cutter
Size:2-6, 6-12, 15-19mm



Glass cutter
Size:2-6, 6-12, 15-19mm



Glass cutter
Size:2-6, 6-12, 15-19mm



Glass cutter
Size:2-6, 6-12, 15-19mm

Glass cutter&plier series



Glass cutter
Size:2-6, 6-12, 15-19mm



Glass cutter
Size:2-6, 6-12, 15-19mm



Glass cutter
Size:2-6, 6-12, 15-19mm



Glass cutter
Size:2-6, 6-12, 15-19mm



Glass cutter
Size:2-6, 6-12, 15-19mm



Glass cutter
Size:2-6, 6-12, 15-19mm



Glass cutter
Size:2-6, 6-12, 15-19mm



Glass cutter
Size:2-6, 6-12, 15-19mm



Glass cutter
Size:2-6, 6-12, 15-19mm



Glass cutter
Size:2-6, 6-12, 15-19mm



Glass cutter
Size:2-6, 6-12, 15-19mm



Carving cutter Glass
Size:2-6, 6-12, 15-19mm

Glass suction lifter series



N001

Single-pad suction lifter
Max: 50kg
D: 123mm



N002

Single-pad suction lifter
Max: 35kg
D: 123mm



N003

Single-pad suction lifter
Max: 50kg
D: 123mm



N004

Pneumatic suction lifter
Max: 150kg
D: 206mm



N005

Pneumatic suction lifter
Max: 150kg
D: 206mm



N006

Pneumatic suction lifter
Max: 100kg
D: 206mm



N007

Pneumatic suction lifter
Max: 150kg
D: 254mm



N008

Pneumatic suction lifter
Max: 120kg
D: 206mm



N009

Pneumatic suction lifter
Max: 40kg
D: 150mm

Glass suction lifter series



N010

Double-pad suction lifter (best)
Max: 135kg
D: 128mm



N011

Single-pad suction lifter
Max: 150kg
D: 185mm



N012

Double-pad suction lifter
Max: 135kg
D: 128mm



N013

Double-pad suction lifter
Max: 100kg
D: 123mm



N014

Double-pad suction lifter (best)
Max: 135kg
D: 123mm



N015

Double-pad suction lifter
Max: 100kg
D: 123mm



N016

Angle suction lifter
D: 75mm D: 56mm



N017

Single-pad suction lifter Suction pad
Max: 15kg D: 56mm

Glass suction lifter series



N018

Triple-pad suction lifter
Max: 155kg
D: 123mm



N019

Triple-pad suction lifter (best)
Max: 210kg
D: 123mm



N020

Triple-pad suction lifter (best)
Max: 210kg
D: 123mm



N021

Triple-pad suction lifter
Max: 150kg
D: 123mm



N022

Angle suction lifter
Max: 35kg
D: 123mm



N023

Adjustable angle suction lifter
Max: 35kg
D: 123mm

Cerium oxide polishing series



O001

Excellent polishing for precious optical lens, LED screen, mobile LED screen ect.

Color: White



O002

Excellent polishing for precious optical lens, LED screen, mobile LED screen ect.

Color: Pink



O003

Excellent polishing for glass edging and beveling Polishing

Color: Light-pink



O004

Excellent polishing for glass edging and beveling Polishing

Color: Creamy-white



O005

Normal use for glass polishing, beveling polishing, mosaic polishing

Color: Creamy-white



O006

Crystal rhinestone polishing

Color: Pink

Glass machinery fittings series



P001

Holding rink for double edging machine



P002

Universal wheel



P003

Backwheels for shape edging machine

Glass machinery fittings series



Front level, backlevel for straight line edging machine, shape edging machine



Water proof



Sucker for shape machine

Glass machinery fittings series



P007

Aluminium plate, holder, aluminium parts



P008

- ①②③ Square base of washing machine
- ④⑤⑥ Round base of washing machine
- ⑦⑧⑨ Cupule base of washing machine
- ⑩⑪ Gear of washing machine

Glass machinery fittings series

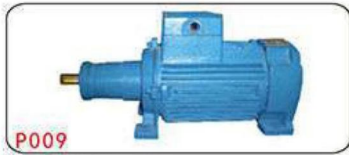

P009

1.5KW 2.2KW
Motor for straight/beveling machine



P010

1.5KW 2.2KW
Motor for double edging machine



P011

1.3-1.8KW 1.8-2.2KW
Motor for shape edging machine



P012

37KW/40D
Stepless speed variator



P013

ABB motor



P014

90W, 125W
Pump for straight edging machine



P015

Motor of chamfering machine



P016

90W 125W
Pump for straight edging machine



P017

Oil pump and oil separator



P018

Timing belt



P019

Timing belt



P020

Sand grinding belt



P021

Timing belt



P022

Belt for motor



P023

Washing machine link



P024

Transportation link



P025

Straight line edging machine link



P026

Straight line beveling machine link

Glass machinery fittings series



P027

Adjustable drilling plate
Size: 150 200 250 250 300mm



P028

Pile joint



P029

Swivel joint



P030

Valve joint



P031

Imported vacuum implement



P032

Domestic vacuum implement



P033

Vacuum generators



P034

Sliding valve



P035

Adjustable valve



P036

Solenoid valve



P037

Triple



P038

Motor carriage



P039

Change direction valve



P040

Change direction valve



P041

Change direction valve



P042

Drilling machine valve



P043

Emergency switch



P044

Starting switch



P045

Limit switch



P046

Reducer



P047

AC contactor



P048

Drilling machine cylinder



P049

Shape edging machine cylinder



P050

Straight ling beveling machine cylinder

Glass machinery fittings series



P051

Spindle for drilling machine



P052

Pressing wheel and bracket for beveling machine



P053

Universal drive shaft for edging machine



P054

Universal drive shaft for beveling machine



P055

Conveyor belt master, passive wheel pressing wheel



P056

Double row master, passive chain wheel



P057

Drilling machine return spring



P058

Gear wheel

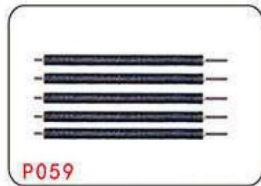

P059

Brush stick
Size:600,800,1000,1200,1600,2500mm
D:55,80,100,120mm

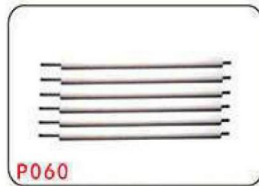

P060

Spongy stick
Size:600,800,1000,1200,1600,2500mm
D:55,80,100,120mm



P061

Rubber stick
Size:600,800,1000,1200,1600,2500mm
D:55,80,100,120mm



P062

Water proof brush
Size:8,10mm



P063

Brush stick



P064

Clean machine rubber tube Brush



P065

Iron sheet



P066

Silk



P067

Digital display



P068

Scale fine-tuning



P069

Corrugated digital handwheel



P070

Twin digital hand wheel

Glass machinery fittings series



P071

Water chuck



P072

Water chuck



P073

Water chuck



P074

Water chuck



P075

Water chuck



P076

Water chuck



P077

Water chuck



P078

Water chuck



P079

Long steam-driven soft gun



P080

Steam-driven soft gun



P081

Rotary glue gun

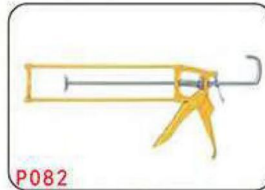

P082

Small-post glue gun



P083

Sand blasting gun



P084

Sand blasting gun



P085

Ceramic nozzle



P086

Tungsten steel nozzle



P087

Switch sand blasting gun



P088

Sand blasting gun



P089

Boron carbide nozzle



P090

Tube

Glass machinery fittings series



P091

Polishing disc
Size: 100mm
G: 60, 80, 100, 120#



P092

Polishing disc
Size: 100mm
G: 60, 80, 100, 120#

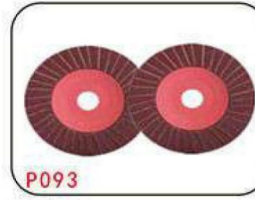

P093

Polishing disc
Size: 100mm
G: 60, 80, 100, 120#



P094

Polishing disc
Size: 100mm
G: 60, 80, 100, 120#



P095

Grinding disc
Size: 80, 100mm

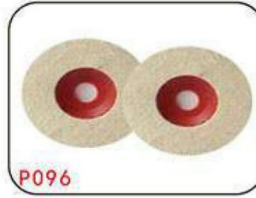

P096

Wood pad
Size: 80mm



P097

Spongy wheel
Size: 70mm



P098

Polishing disc
G: 120# 220# 400# 600#



P099

Imported cutting disc
Size: 80mm



P100

Imported cutting disc
Size: 85mm

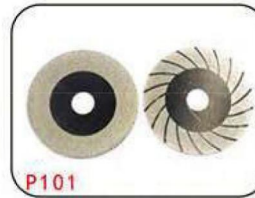

P101

Electroplated cutting disc
Size: 100mm



P102

Electroplated grinding disc
Size: 100mm



P103

Cutting disc
Size: 80, 85, 100mm



P104

Electroplated cutting disc Slider
Size: 50mm



P105



P106

Suction pad



P107

High temperature rope



P108

Tempering furnace apron



P109

Scale belt



P110

Desiccant

Glass machinery fittings series



P111

Cutter wheel



P112

Rubber remover for laminated glass



P113

cutting head



P114

Shape cutting head



P115

Guide wheel



P116

Ushape cutter head



P117

Glass cutter head



P118

Roller



P119

Wool felt

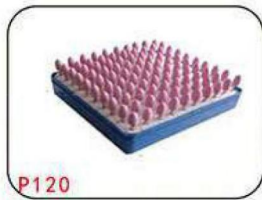

P120

Grinding head



P121

Electroplated grinding head



P122

Grinding belt



P123

Polyurethane pad



P124

Spongy pad



P125

Cork(with sponge)



P126

Cork(without sponge)



P127

Glass breaking tool machine



P128

Glass plastic frame



P129

Handle of polishing



P130

Felt pad

Glass machinery fittings series



P131

Plastic piece



P132

Support guide wheel



P133

Support guide wheel



P134

Support guide wheel



P135

Glass protective film



P136

White corundum



P137

Whetstone



P138

Mirror edge sealer



P139

Electroplated wheel



P140

Sucker



P141

Water pipe



P142

Diamond hand pad



P143

Glass protective angle



P144

U type plastic clip



P145

Plastic piece



P146

Clear Plastic piece



P147

Blasting sand
G: 46, 60, 80, 100, 120#



P148

Metal fiber



P149

Shining powder



P150

Glass leaded

Glass machine seri

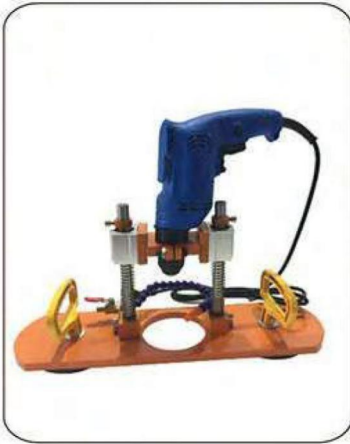

Small drilling machine



Small drilling machine



Small drilling machine



Small drilling machine



Small drilling machine



Small drilling machine





Glass Galore Tools and Solutions LLC